

## 扁头内凹槽数显卡尺

## 135系列

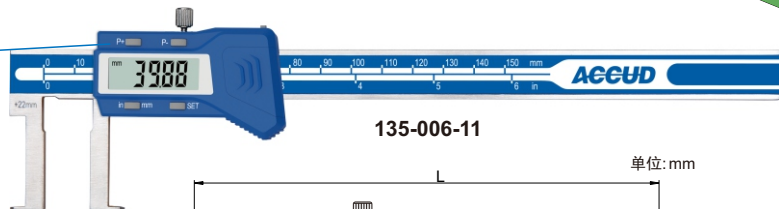

- ◆ 用于测量内凹槽等
- ◆ 分辨率: 0.01mm/0.0005"
- ◆ 按键: 公/英制转换, 设置数值, 数值预置(P+, P-)
- ◆ 滑动开机, 自动关机
- ◆ 带数据输出
- ◆ 不锈钢尺身

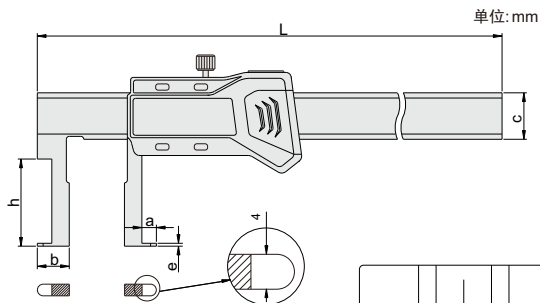

500mm以上芯片

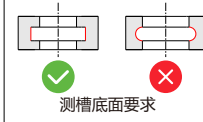
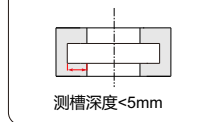
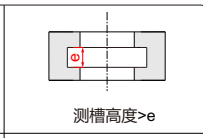
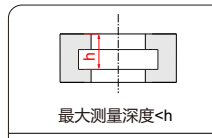
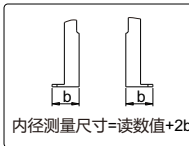
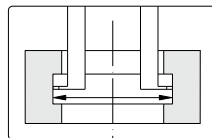

货号	量程	精度	a	b	c	e	h	L
135-006-11	22-150mm	±0.04mm	5	11	16	1	30	250
135-008-11	25-200mm	±0.04mm	5	12.5	16	1	40	310
135-012-11	30-300mm	±0.05mm	5	15	17	1.5	50	410
135-020-11	80-500mm	±0.07mm	16	40	24	4	90	680
135-006-12	35-150mm	±0.06mm	6	17.5	16	1.5	60	250
135-008-12	40-200mm	±0.06mm	7	20	16	1.5	70	310
135-012-12	50-300mm	±0.07mm	8	25	16	1.5	80	410
135-020-12	80-500mm	±0.08mm	16	40	24	5	150	680